

LOCKOUTER

DOWEL PIN

KNOCKOUTER

DOWEL

LOCKOUTER

DOWEL

PIN

KNOCKOUTER

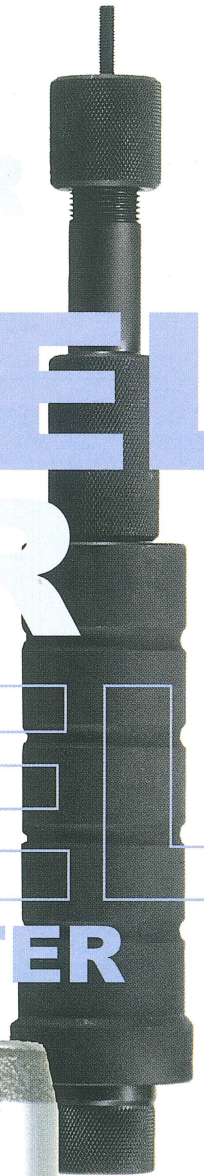
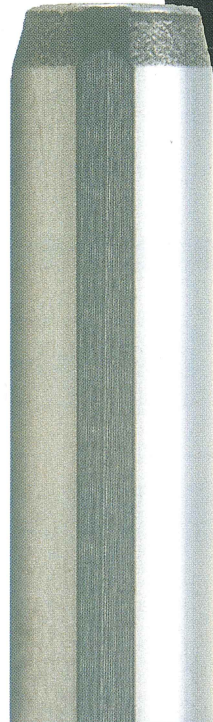
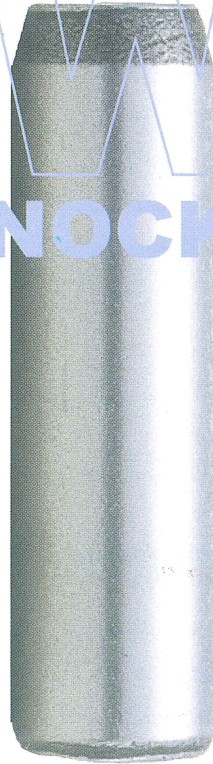

**DOWEL PIN
KNOCKOUTER**

ノックピン/ノックアウト

ストレートノックピン



◎ IS (ストレートタイプ)

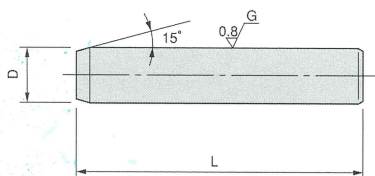

材質 SUJ2
硬度 55HRC~

CATALOG NO.		Dm5	L														
TYPE	D																
IS	3	$\begin{matrix} +0.006 \\ +0.002 \end{matrix}$	10	15	20	25	30										
	4		10	15	20	25	30	35	40								
	5	$\begin{matrix} +0.009 \\ +0.004 \end{matrix}$	10	15	20	25	30	35	40	50							
	6			15	20	25	30	35	40	45	50	60					
	8	$\begin{matrix} +0.012 \\ +0.006 \end{matrix}$			20	25	30	35	40	45	50	55	60	70	80		
	10	$\begin{matrix} +0.012 \\ +0.006 \end{matrix}$			20	25	30	35	40	50	60	70	80				
12	$\begin{matrix} +0.015 \\ +0.007 \end{matrix}$					30	40	50	60	70	80						

タップ付プラス公差ノックピン



◎ IST (タップ付m5タイプ)

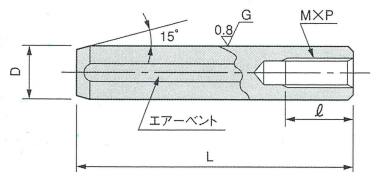

材質 SUJ2
硬度 45~50HRC

CATALOG NO.		Dm5	M×P×ℓ	L													
TYPE	D																
IST	6	$\begin{matrix} +0.009 \\ +0.004 \end{matrix}$	M 4×0.7 × 8	15	20	25	30	35	40	45	50						
	8	$\begin{matrix} +0.012 \\ +0.006 \end{matrix}$	M 5×0.8 × 8		20	25	30	35	40	45	50	60	70	80			
	10	$\begin{matrix} +0.012 \\ +0.006 \end{matrix}$	M 6×1.0 ×10		20	25	30	35	40	45	50	60	70	80			
	12		M 6×1.0 ×10				30		40	45	50	60	70	80			
	13	$\begin{matrix} +0.015 \\ +0.007 \end{matrix}$	M 8×1.25×15						40	45	50	60	70	80	90	100	
	16	$\begin{matrix} +0.015 \\ +0.007 \end{matrix}$	M 8×1.25×15						40	50	60	70	80	90	100		
20	$\begin{matrix} +0.017 \\ +0.008 \end{matrix}$	M10×1.5 ×18							50	60	70	80	90	100			

タップ付マイナス公差ノックピン



◎ ISTH (タップ付h6タイプ)

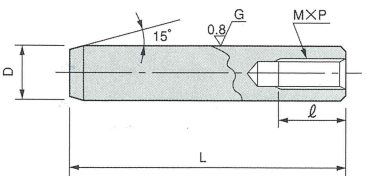

材質 SUJ2
硬度 45~50HRC

CATALOG NO.		Dh6	M×P×ℓ	L													
TYPE	D																
ISTH	6	$\begin{matrix} 0 \\ -0.008 \end{matrix}$	M 4×0.7 × 8	20	25	30	35	40	45	50							
	8	$\begin{matrix} 0 \\ -0.009 \end{matrix}$	M 5×0.8 × 8	20	25	30	35	40	45	50	60	70	80				
	10		M 6×1.0 ×10	20	25	30	35	40	45	50	60	70	80				
	12		M 6×1.0 ×10				30		40	45	50	60	70	80			
	13	$\begin{matrix} 0 \\ -0.011 \end{matrix}$	M 8×1.25×15						40	45	50	60	70	80	90	100	
	16	$\begin{matrix} 0 \\ -0.011 \end{matrix}$	M 8×1.25×15						40	50	60	70	80	90	100		
20	$\begin{matrix} 0 \\ -0.013 \end{matrix}$	M10×1.5 ×18							50	60	70	80	90	100			

■ 注文方法 CATALOG NO. × L

注文例 IS 10 × 40

ノックアウト

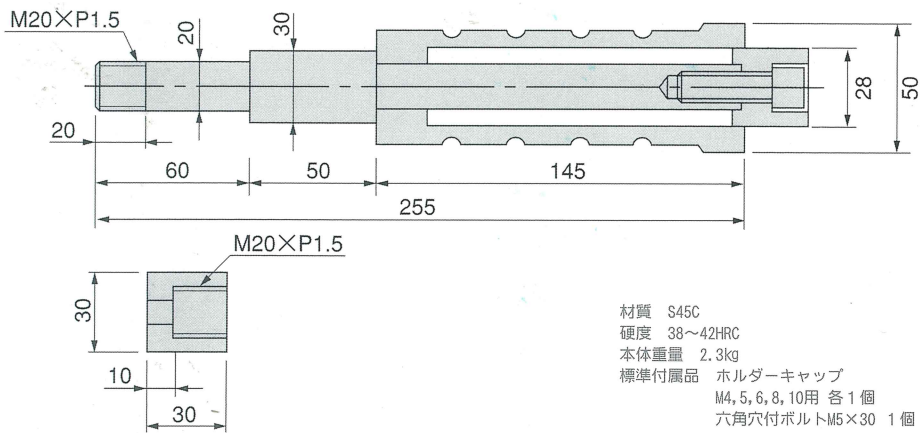
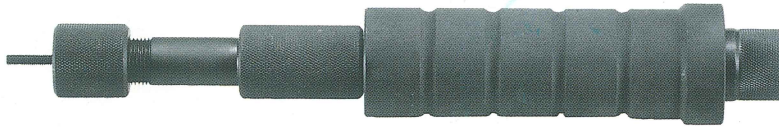

使用方法

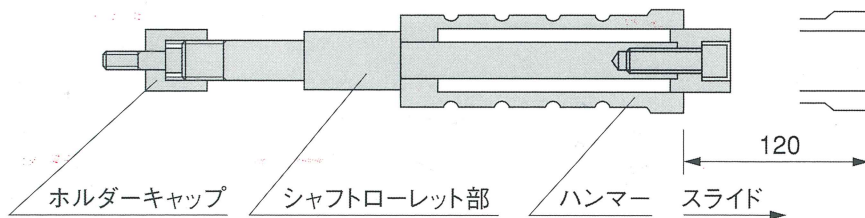

1. ホルダーキャップに六角穴付ボルトを挿入する。
2. 本体先端部にホルダーキャップを取り付ける。
3. シャフトローレット部を回して、ボルトの先端をノックピンにねじ込む。
4. ハンマーをスライドさせ、ノックピンを引き抜く。

■ 注文方法 CATALOG NO.

注文例 ノックアウト